

ADMISSION OPEN

ONE YEAR NEET REPEATER COURSE

(2019-2020)

STARTING ON 17th MAY 2019



BOOKLET CODE - R4

SPIRO PRIME EDUCATION INSTITUTES

BOOKLET CODE: - R4 ANSWER KEY

| Q.No | Answer | Q.No | Answer | Q.No | Answer | Q.No | Answer |
|------|--------|------|----------|------|--------|------|--------|
| 1 | 2 | 46 | 3 | 91 | 3 | 136 | 2 |
| 2 | 1 | 47 | 4 | 92 | 4 | 137 | 4 |
| 3 | 2 | 48 | 4 | 93 | 3 | 138 | 3 |
| 4 | 4 | 49 | 1 | 94 | 2 | 139 | 3 |
| 5 | 3 | 50 | 3 | 95 | 2 | 140 | 3 |
| 6 | 4 | 51 | 3 | 96 | 1 | 141 | 4 |
| 7 | 1 | 52 | 1 | 97 | 4 | 142 | 2 |
| 8 | 2 | 53 | 2 | 98 | 3 | 143 | 3 |
| 9 | 2 | 54 | 2 | 99 | 4 | 144 | 2 |
| 10 | 3 | 55 | 1 | 100 | 2 | 145 | 1 |
| 11 | 4 | 56 | 4 | 101 | 2 | 146 | 3 |
| 12 | 3 | 57 | 4 | 102 | 3 | 147 | 2 |
| 13 | 3 | 58 | 4 | 103 | 2 | 148 | 4 |
| 14 | 4 | 59 | 3 | 104 | 3 | 149 | 3 |
| 15 | 2 | 60 | 3 | 105 | 1 | 150 | 4 |
| 16 | 4 | 61 | 2 | 106 | 4 | 151 | 1 |
| 17 | 3 | 62 | 3 | 107 | 2 | 152 | 1 |
| 18 | 2 | 63 | 2 | 108 | 2 | 153 | 4 |
| 19 | 2 | 64 | 4 | 109 | 3 | 154 | 4 |
| 20 | 4 | 65 | 3 | 110 | 3 | 155 | 3 |
| 21 | 4 | 66 | 3 | 111 | 3 | 156 | 1 |
| 22 | 1 | 67 | 4 | 112 | 2 | 157 | 1 |
| 23 | 1 | 68 | 2 | 113 | 1 | 158 | 4 |
| 24 | 3 | 69 | 3 | 114 | 1 | 159 | 4 |
| 25 | 3 | 70 | 2 | 115 | 3 | 160 | 3 |
| 26 | 3 | 71 | 1 | 116 | 1 | 161 | 1 |
| 27 | 1 | 72 | 1 | 117 | 2 | 162 | 3 |
| 28 | 3 | 73 | 1 | 118 | 3 | 163 | 4 |
| 29 | 4 | 74 | 2 (or) 3 | 119 | 3 | 164 | 4 |
| 30 | 1 | 75 | 4 | 120 | 3 | 165 | 3 |
| 31 | 4 | 76 | 2 | 121 | 4 | 166 | 3 |
| 32 | 2 | 77 | 4 | 122 | 1 | 167 | 4 |
| 33 | 4 | 78 | 1 | 123 | 4 | 168 | 1 |
| 34 | 3 | 79 | 4 | 124 | 4 | 169 | 2 |
| 35 | 4 | 80 | 3 | 125 | 4 | 170 | 3 |
| 36 | 2 | 81 | 3 | 126 | 4 | 171 | 4 |
| 37 | 1 | 82 | 1 | 127 | 1 | 172 | 2 |
| 38 | 2 | 83 | 1 | 128 | 1 | 173 | 1 |
| 39 | 3 | 84 | 2 | 129 | 3 | 174 | 2 |
| 40 | 1 | 85 | 1 | 130 | 2 | 175 | 3 |
| 41 | 4 | 86 | 3 | 131 | 4 | 176 | 1 |
| 42 | 4 | 87 | 1 | 132 | 1 | 177 | 3 |
| 43 | 3 | 88 | 4 | 133 | 2 | 178 | 4 |
| 44 | 4 | 89 | 1 | 134 | 4 | 179 | 4 |
| 45 | 2 | 90 | 3 | 135 | 4 | 180 | 4 |

Though every care has been taken to provide the answers correctly but the institute shall not be responsible for any typographical error, if any.

ADMISSION OPEN

ONE YEAR

NEET REPEATER COURSE

(2019-2020)

STARTING ON 17th MAY 2019



No.3, 2nd floor, Singaravelu St, (Behind BIG BAZAAR) T.Nagar,
Chennai - 17, Tamilnadu, India.

Mobile : **733 888 4137, 733 888 4136**

spiroacademy.com || info@spiroacademy.com

TOP RANKERS ALWAYS FROM SPIRO

R4

This Booklet contains 24 pages.

Do not open this Test Booklet until you are asked to do so.

Important Instructions :

1. The Answer Sheet is inside this Test Booklet. When you are directed to open the Test Booklet, take out the Answer Sheet and fill in the particulars on **side-1** and **side-2** carefully with **blue/black** ball point pen only.
2. The test is of **3 hours** duration and Test Booklet contains **180** questions. Each question carries **4** marks. For each correct response, the candidate will get **4** marks. For each incorrect response, **one mark** will be deducted from the total scores. The maximum marks are **720**.
3. Use **Blue/Black Ball Point Pen only** for writing particulars on this page/markings responses.
4. Rough work is to be done on the space provided for this purpose in the Test Booklet only.
5. **On completion of the test, the candidate must hand over the Answer Sheet to the invigilator before leaving the Room/Hall. The candidates are allowed to take away this Test Booklet with them.**
6. The CODE for this Booklet is **R4**. Make sure that the CODE printed on **Side-2** of the Answer Sheet is the same as that on this Test Booklet. In case of discrepancy, the candidate should immediately report the matter to the Invigilator for replacement of both the Test Booklet and the Answer Sheet.
7. The candidates should ensure that the Answer Sheet is not folded. Do not make any stray marks on the Answer Sheet. Do not write your Roll No. anywhere else except in the specified space in the Test Booklet/ Answer Sheet.
8. Use of white fluid for correction is **NOT** permissible on the Answer Sheet.
9. Each candidate must show on demand his/her Admit Card to the Invigilator.
10. No candidate, without special permission of the Superintendent or Invigilator, would leave his/her seat.
11. The candidates should not leave the Examination Hall without handing over their Answer Sheet to the Invigilator on duty and sign the Attendance Sheet twice. **Cases where a candidate has not signed the Attendance Sheet second time will be deemed not to have handed over the Answer Sheet and dealt with as an unfair means case.**
12. Use of Electronic/Manual Calculator is prohibited.
13. The candidates are governed by all Rules and Regulations of the examination with regard to their conduct in the Examination Hall. All cases of unfair means will be dealt with as per Rules and Regulations of this examination.
14. No part of the Test Booklet and Answer Sheet shall be detached under any circumstances.
15. The candidates will write the Correct Test Booklet Code as given in the Test Booklet/Answer Sheet in the Attendance Sheet.

Name of the Candidate (in Capitals) : KALAIARAJ.SRoll Number : in figures 410802339: in words Forty one crore Eight lakh two thousand three hundred thirty nineCentre of Examination (in Capitals) : SELVAM COLLEGE TECHNOLOGY, NAMAKKALCandidate's Signature : S. Kaliraj Invigilator's Signature : J. Thulluilly

Fascimile signature stamp of

Centre Superintendent : 

SEAL

1. Among the following, the narrow spectrum antibiotic is :
- chloramphenicol
 - penicillin G
 - ampicillin
 - amoxycillin
2. Among the following, the one that is **not** a green house gas is :
- sulphur dioxide
 - nitrous oxide
 - methane
 - ozone
3. Which of the following reactions are disproportionation reaction?
- $2\text{Cu}^+ \rightarrow \text{Cu}^{2+} + \text{Cu}^0$
 - $3\text{MnO}_4^{2-} + 4\text{H}^+ \rightarrow 2\text{MnO}_4^- + \text{MnO}_2 + 2\text{H}_2\text{O}$
 - $2\text{KMnO}_4 \xrightarrow{\Delta} \text{K}_2\text{MnO}_4 + \text{MnO}_2 + \text{O}_2$
 - $2\text{MnO}_4^- + 3\text{Mn}^{2+} + 2\text{H}_2\text{O} \rightarrow 5\text{MnO}_2 + 4\text{H}^+$

Select the **correct** option from the following :

- (a) and (d) only *
 - (a) and (b) only
 - (a), (b) and (c)
 - (a), (c) and (d) *
4. Which of the following diatomic molecular species has only π bonds according to Molecular Orbital Theory?
- Be_2
 - O_2
 - N_2
 - C_2
5. Match the Xenon compounds in **Column - I** with its structure in **Column - II** and assign the correct code :

| Column - I | Column - II |
|---------------------|----------------------------|
| (a) XeF_4 | (i) pyramidal |
| (b) XeF_6 | (ii) square planar |
| (c) XeOF_4 | (iii) distorted octahedral |
| (d) XeO_3 | (iv) square pyramidal |

Code :

- | | (a) | (b) | (c) | (d) |
|-----|-------|-------|-------|--------|
| (1) | (iii) | (iv) | (i) | (ii) * |
| (2) | (i) | (ii) | (iii) | (iv) |
| (3) | (ii) | (iii) | (iv) | (i) * |
| (4) | (ii) | (iii) | (i) | (iv) |

6. The non-essential amino acid among the following is :
- lysine
 - valine *
 - leucine
 - alanine *
7. Which one is malachite from the following?
- $\text{CuCO}_3 \cdot \text{Cu}(\text{OH})_2$
 - CuFeS_2
 - $\text{Cu}(\text{OH})_2$
 - Fe_3O_4
8. The **correct** structure of tribromooxide is :

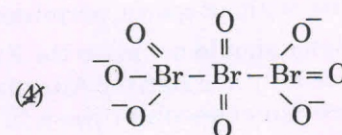
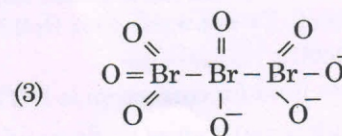
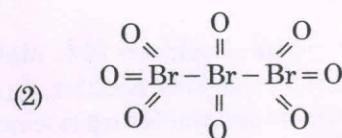
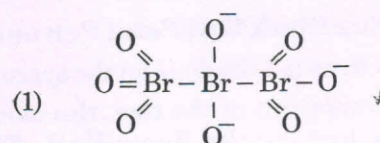

9. The mixture that forms maximum boiling azeotrope is :
- Heptane + Octane
 - Water + Nitric acid
 - Ethanol + Water
 - Acetone + Carbon disulphide
10. The most suitable reagent for the following conversion, is :

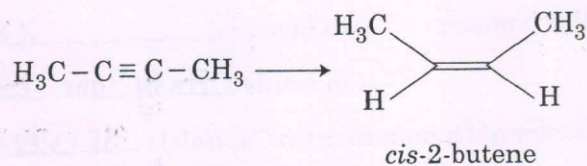

- $\text{Hg}^{2+} / \text{H}^+, \text{H}_2\text{O}$
- $\text{Na} / \text{liquid NH}_3$
- $\text{H}_2, \text{Pd} / \text{C}, \text{quinoline}$
- Zn / HCl

11. Which will make basic buffer ?

- (1) 100 mL of 0.1 M HCl + 100 mL of 0.1 M NaOH
- (2) 50 mL of 0.1 M NaOH + 25 mL of 0.1 M CH_3COOH
- (3) 100 mL of 0.1 M CH_3COOH + 100 mL of 0.1 M NaOH
- (4) 100 mL of 0.1 M HCl + 200 mL of 0.1 M NH_4OH

12. The structure of intermediate A in the following reaction, is :

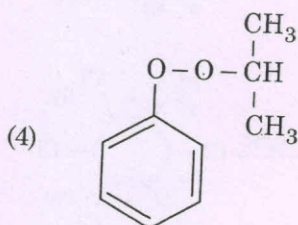
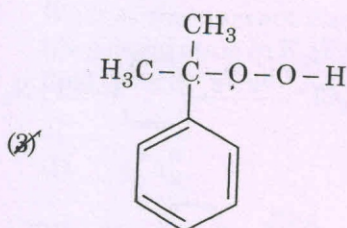
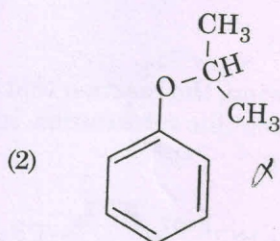
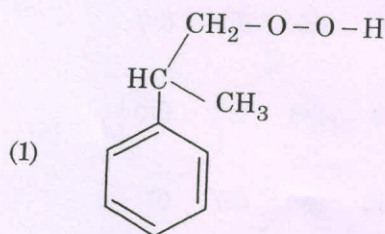
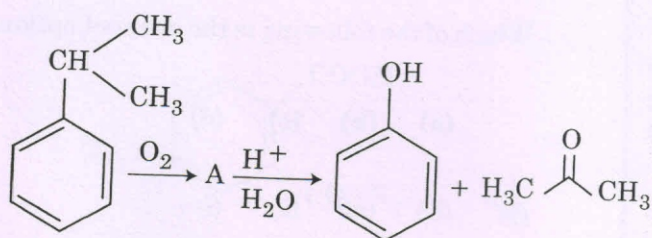

13. The biodegradable polymer is :

- (1) Buna-S
- (2) nylon-6, 6
- (3) nylon 2-nylon 6
- (4) nylon-6

14. A compound is formed by cation C and anion A. The anions form hexagonal close packed (hcp) lattice and the cations occupy 75% of octahedral voids. The formula of the compound is :

- (1) C_4A_3
- (2) C_2A_3
- (3) C_3A_2
- (4) C_3A_4

15. 4d, 5p, 5f and 6p orbitals are arranged in the order of decreasing energy. The correct option is :

- (1) $5f > 6p > 4d > 5p$
- (2) $5f > 6p > 5p > 4d$
- (3) $6p > 5f > 5p > 4d$
- (4) $6p > 5f > 4d > 5p$

16. The manganate and permanganate ions are tetrahedral, due to :

- (1) The π -bonding involves overlap of d-orbitals of oxygen with d-orbitals of manganese
- (2) The π -bonding involves overlap of p-orbitals of oxygen with d-orbitals of manganese
- (3) There is no π -bonding
- (4) The π -bonding involves overlap of p-orbitals of oxygen with p-orbitals of manganese

17. For the second period elements the correct increasing order of first ionisation enthalpy is :

- (1) $\text{Li} < \text{Be} < \text{B} < \text{C} < \text{O} < \text{N} < \text{F} < \text{Ne}$
- (2) $\text{Li} < \text{Be} < \text{B} < \text{C} < \text{N} < \text{O} < \text{F} < \text{Ne}$
- (3) $\text{Li} < \text{B} < \text{Be} < \text{C} < \text{O} < \text{N} < \text{F} < \text{Ne}$
- (4) $\text{Li} < \text{B} < \text{Be} < \text{C} < \text{N} < \text{O} < \text{F} < \text{Ne}$

18. Under isothermal condition, a gas at 300 K expands from 0.1 L to 0.25 L against a constant external pressure of 2 bar. The work done by the gas is :

[Given that 1 L bar = 100 J]

- (1) 30 J
- (2) - 30 J
- (3) 5 kJ
- (4) 25 J

19. For the cell reaction

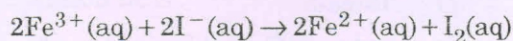

$E_{\text{cell}}^{\ominus} = 0.24 \text{ V}$ at 298 K. The standard Gibbs energy ($\Delta_r G^{\ominus}$) of the cell reaction is :

[Given that Faraday constant $F = 96500 \text{ C mol}^{-1}$]

- (1) $23.16 \text{ kJ mol}^{-1}$
 (2) $-46.32 \text{ kJ mol}^{-1}$
 (3) $-23.16 \text{ kJ mol}^{-1}$
 (4) $46.32 \text{ kJ mol}^{-1}$

20. A gas at 350 K and 15 bar has molar volume 20 percent smaller than that for an ideal gas under the same conditions. The **correct** option about the gas and its compressibility factor (Z) is :

- (1) $Z < 1$ and repulsive forces are dominant
 (2) $Z > 1$ and attractive forces are dominant
 (3) $Z > 1$ and repulsive forces are dominant
 (4) $Z < 1$ and attractive forces are dominant

21. For a cell involving one electron $E_{\text{cell}}^{\ominus} = 0.59 \text{ V}$ at 298 K, the equilibrium constant for the cell reaction is :

[Given that $\frac{2.303 RT}{F} = 0.059 \text{ V}$ at $T = 298 \text{ K}$]

- (1) 1.0×10^{30}
 (2) 1.0×10^2
 (3) 1.0×10^5
 (4) 1.0×10^{10}

22. The compound that is most difficult to protonate is :

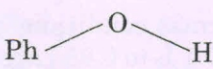
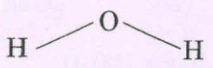
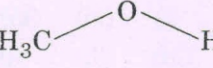
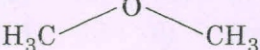
- (1) 
 (2) 
 (3) 
 (4) 

23. Match the following :

- | | |
|----------------------|-----------------------------------|
| (a) Pure nitrogen | (i) Chlorine |
| (b) Haber process | (ii) Sulphuric acid |
| (c) Contact process | (iii) Ammonia |
| (d) Deacon's process | (iv) Sodium azide or Barium azide |

Which of the following is the **correct** option ?

- (a) (b) (c) (d)
 (1) (i) (ii) (iii) (iv)
 (2) (i) (ii) (iii) (iv)
 (3) (ii) (iv) (i) (iii)
 (4) (iii) (iv) (ii) (i)

24. Among the following, the reaction that proceeds through an electrophilic substitution, is :

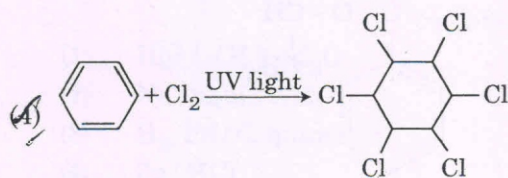
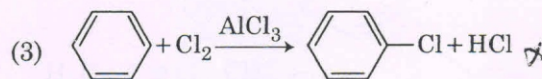
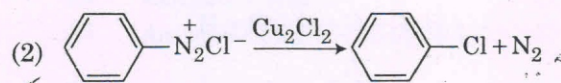
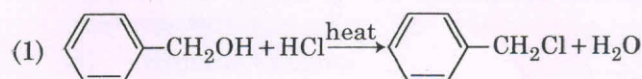

25. The major product of the following reaction is :

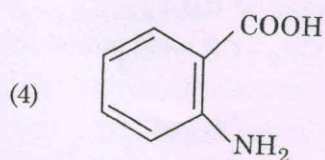
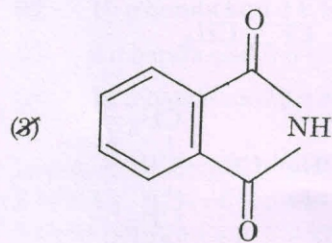
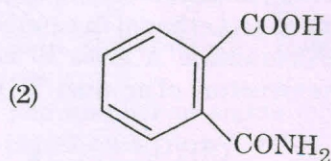
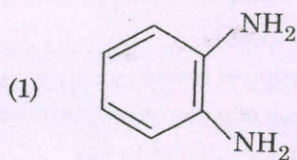
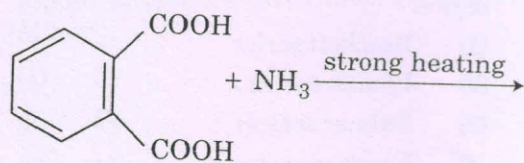

26. What is the **correct** electronic configuration of the central atom in $K_4[Fe(CN)_6]$ based on crystal field theory?

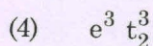
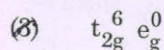
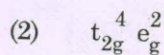
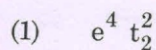

27. Identify the **incorrect** statement related to PCl_5 from the following :

(1) PCl_5 molecule is non-reactive

(2) Three equatorial P-Cl bonds make an angle of 120° with each other ✓

(3) Two axial P-Cl bonds make an angle of 180° with each other ✓

(4) Axial P-Cl bonds are longer than equatorial P-Cl bonds ✓

28. The method used to remove temporary hardness of water is :

(1) Synthetic resins method

(2) Calgon's method

(3) Clark's method

(4) Ion-exchange method

29. Conjugate base for Brönsted acids H_2O and HF are :

(1) H_3O^+ and H_2F^+ , respectively

(2) OH^- and H_2F^+ , respectively ✓

(3) H_3O^+ and F^- , respectively ✓

(4) OH^- and F^- , respectively

30. Which of the following species is **not** stable ?

(1) $[SiCl_6]^{2-}$

(2) $[SiF_6]^{2-}$ ✓

(3) $[GeCl_6]^{2-}$

(4) $[Sn(OH)_6]^{2-}$

31. The number of moles of hydrogen molecules required to produce 20 moles of ammonia through Haber's process is :

(1) 40

(2) 10

(3) 20

(4) 30

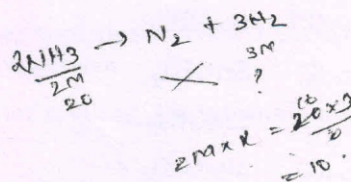

32. Which of the following is **incorrect** statement ?

(1) SnF_4 is ionic in nature

(2) PbF_4 is covalent in nature

(3) $SiCl_4$ is easily hydrolysed

(4) GeX_4 ($X = F, Cl, Br, I$) is more stable than GeX_2

33. If the rate constant for a first order reaction is k , the time (t) required for the completion of 99% of the reaction is given by :

- (1) $t = 2.303/k$
 (2) $t = 0.693/k$
 (3) $t = 6.909/k$
 (4) $t = 4.606/k$

34. Which mixture of the solutions will lead to the formation of negatively charged colloidal $[AgI]I^-$ sol. ?

- (1) 50 mL of 0.1 M $AgNO_3$ + 50 mL of 0.1 M KI
 (2) 50 mL of 1 M $AgNO_3$ + 50 mL of 1.5 M KI
 (3) 50 mL of 1 M $AgNO_3$ + 50 mL of 2 M KI
 (4) 50 mL of 2 M $AgNO_3$ + 50 mL of 1.5 M KI

35. For an ideal solution, the correct option is :

- (1) $\Delta_{mix} G = 0$ at constant T and P
 (2) $\Delta_{mix} S = 0$ at constant T and P
 (3) $\Delta_{mix} V \neq 0$ at constant T and P
 (4) $\Delta_{mix} H = 0$ at constant T and P

36. pH of a saturated solution of $Ca(OH)_2$ is 9. The solubility product (K_{sp}) of $Ca(OH)_2$ is :

- (1) 0.5×10^{-10}
 (2) 0.5×10^{-15}
 (3) 0.25×10^{-10}
 (4) 0.125×10^{-15}

37. Which of the following is an amphoteric hydroxide ?

- (1) $Be(OH)_2$
 (2) $Sr(OH)_2$
 (3) $Ca(OH)_2$
 (4) $Mg(OH)_2$

38. The correct order of the basic strength of methyl substituted amines in aqueous solution is :

- (1) $CH_3NH_2 > (CH_3)_2NH > (CH_3)_3N$
 (2) $(CH_3)_2NH > CH_3NH_2 > (CH_3)_3N$
 (3) $(CH_3)_3N > CH_3NH_2 > (CH_3)_2NH$
 (4) $(CH_3)_3N > (CH_3)_2NH > CH_3NH_2$

39. Which of the following series of transitions in spectrum of hydrogen atom falls in visible region ?

- (1) Brackett series
 (2) Lyman series
 (3) Balmer series
 (4) Paschen series

40. In which case change in entropy is negative ?

- (1) $2H(g) \rightarrow H_2(g)$
 (2) Evaporation of water
 (3) Expansion of a gas at constant temperature
 (4) Sublimation of solid to gas

41. An alkene "A" on reaction with O_3 and $Zn-H_2O$ gives propanone and ethanal in equimolar ratio. Addition of HCl to alkene "A" gives "B" as the major product. The structure of product "B" is :

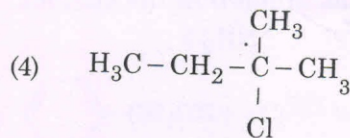
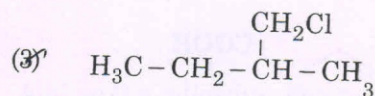
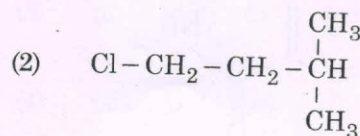
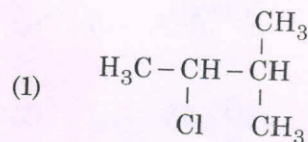

42. For the chemical reaction

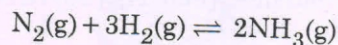

the correct option is :

(1) $3 \frac{d[H_2]}{dt} = 2 \frac{d[NH_3]}{dt}$

(2) $-\frac{1}{3} \frac{d[H_2]}{dt} = -\frac{1}{2} \frac{d[NH_3]}{dt}$

(3) $-\frac{d[N_2]}{dt} = 2 \frac{d[NH_3]}{dt}$

(4) $-\frac{d[N_2]}{dt} = \frac{1}{2} \frac{d[NH_3]}{dt}$

43. Enzymes that utilize ATP in phosphate transfer require an alkaline earth metal (M) as the cofactor. M is :
- (1) Sr
 - (2) Be
 - (3) Mg
 - (4) Ca
44. Which is the **correct** thermal stability order for H_2E (E = O, S, Se, Te and Po) ?
- (1) $H_2Se < H_2Te < H_2Po < H_2O < H_2S$
 - (2) $H_2S < H_2O < H_2Se < H_2Te < H_2Po$
 - (3) $H_2O < H_2S < H_2Se < H_2Te < H_2Po$
 - (4) $H_2Po < H_2Te < H_2Se < H_2S < H_2O$
45. The number of sigma (σ) and pi (π) bonds in pent-2-en-4-yne is :
- (1) 13 σ bonds and no π bond
 - (2) 10 σ bonds and 3 π bonds
 - (3) 8 σ bonds and 5 π bonds
 - (4) 11 σ bonds and 2 π bonds
46. In a species, the weight of newborn ranges from 2 to 5 kg. 97% of the newborn with an average weight between 3 to 3.3 kg survive whereas 99% of the infants born with weights from 2 to 2.5 kg or 4.5 to 5 kg die. Which type of selection process is taking place ?
- (1) Cyclical Selection
 - (2) Directional Selection
 - (3) Stabilizing Selection
 - (4) Disruptive Selection
47. Which of the following sexually transmitted diseases is **not** completely curable ?
- (1) Chlamydia
 - (2) Gonorrhoea
 - (3) Genital warts
 - (4) Genital herpes
48. Identify the cells whose secretion protects the lining of gastro-intestinal tract from various enzymes.
- (1) Duodenal Cells
 - (2) Chief Cells
 - (3) Goblet Cells
 - (4) Oxyntic Cells
49. Which of the following ecological pyramids is generally inverted ?
- (1) Pyramid of biomass in a sea
 - (2) Pyramid of numbers in grassland
 - (3) Pyramid of energy
 - (4) Pyramid of biomass in a forest
50. DNA precipitation out of a mixture of biomolecules can be achieved by treatment with :
- (1) Chilled chloroform
 - (2) Isopropanol
 - (3) Chilled ethanol
 - (4) Methanol at room temperature
51. Variations caused by mutation, as proposed by Hugo de Vries, are :
- (1) small and directionless
 - (2) random and directional
 - (3) random and directionless
 - (4) small and directional
52. Phloem in gymnosperms lacks :
- (1) Both sieve tubes and companion cells
 - (2) Albuminous cells and sieve cells
 - (3) Sieve tubes only
 - (4) Companion cells only
53. Which of the following contraceptive methods do involve a role of hormone ?
- (1) Pills, Emergency contraceptives, Barrier methods
 - (2) Lactational amenorrhea, Pills, Emergency contraceptives
 - (3) Barrier method, Lactational amenorrhea, Pills
 - (4) CuT, Pills, Emergency contraceptives
54. Which of the following can be used as a biocontrol agent in the treatment of plant disease ?
- (1) *Lactobacillus*
 - (2) *Trichoderma*
 - (3) *Chlorella*
 - (4) *Anabaena*

55. Select the correct option.

- (1) There are seven pairs of vertebrosteral, three pairs of vertebrochondral and two pairs of vertebral ribs.
- (2) 8th, 9th and 10th pairs of ribs articulate directly with the sternum.
- (3) 11th and 12th pairs of ribs are connected to the sternum with the help of hyaline cartilage.
- (4) Each rib is a flat thin bone and all the ribs are connected dorsally to the thoracic vertebrae and ventrally to the sternum.

56. Consider the following statements :

- (A) Coenzyme or metal ion that is tightly bound to enzyme protein is called prosthetic group.
- (B) A complete catalytic active enzyme with its bound prosthetic group is called apoenzyme.

Select the correct option.

- (1) (A) is false but (B) is true.
- (2) Both (A) and (B) are true.
- (3) (A) is true but (B) is false.
- (4) Both (A) and (B) are false.

57. The correct sequence of phases of cell cycle is :

- (1) $G_1 \rightarrow S \rightarrow G_2 \rightarrow M$
- (2) $M \rightarrow G_1 \rightarrow G_2 \rightarrow S$
- (3) $G_1 \rightarrow G_2 \rightarrow S \rightarrow M$
- (4) $S \rightarrow G_1 \rightarrow G_2 \rightarrow M$

58. Concanavalin A is :

- (1) a pigment
- (2) an alkaloid.
- (3) an essential oil.
- (4) a lectin

59. Which of the following is a commercial blood cholesterol lowering agent ?

- (1) Lipases
- (2) Cyclosporin A
- (3) Statin
- (4) Streptokinase

60. Purines found both in DNA and RNA are :

- (1) Cytosine and thymine
- (2) Adenine and thymine
- (3) Adenine and guanine
- (4) Guanine and cytosine

61. Expressed Sequence Tags (ESTs) refers to :

- (1) Novel DNA sequences .
- (2) Genes expressed as RNA
- (3) Polypeptide expression
- (4) DNA polymorphism .

62. Which of the following features of genetic code does allow bacteria to produce human insulin by recombinant DNA technology ?

- (1) Genetic code is specific
- (2) Genetic code is not ambiguous
- (3) Genetic code is redundant
- (4) Genetic code is nearly universal

63. What would be the heart rate of a person if the cardiac output is 5 L, blood volume in the ventricles at the end of diastole is 100 mL and at the end of ventricular systole is 50 mL ?

- (1) 125 beats per minute
- (2) 50 beats per minute
- (3) 75 beats per minute
- (4) 100 beats per minute

64. Match the hominids with their correct brain size :

- | | |
|----------------------------------|--------------------|
| (a) <i>Homo habilis</i> | (i) 900 cc |
| (b) <i>Homo neanderthalensis</i> | (ii) 1350 cc |
| (c) <i>Homo erectus</i> | (iii) 650 - 800 cc |
| (d) <i>Homo sapiens</i> | (iv) 1400 cc |

Select the correct option.

- | | (a) | (b) | (c) | (d) |
|-----|-------|-------|------|------|
| (1) | (iv) | (iii) | (i) | (ii) |
| (2) | (iii) | (i) | (iv) | (ii) |
| (3) | (iii) | (ii) | (i) | (iv) |
| (4) | (iii) | (iv) | (i) | (ii) |

65. Match the following organisms with the products they produce :

- | | |
|-------------------------------------|-------------------|
| (a) <i>Lactobacillus</i> | (i) Cheese |
| (b) <i>Saccharomyces cerevisiae</i> | (ii) Curd |
| (c) <i>Aspergillus niger</i> | (iii) Citric Acid |
| (d) <i>Acetobacter aceti</i> | (iv) Bread |
| | (v) Acetic Acid |

Select the **correct** option.

- | | | | | |
|-----|-------|------|-------|-------|
| | (a) | (b) | (c) | (d) |
| (1) | (ii) | (i) | (iii) | (v) |
| (2) | (ii) | (iv) | (v) | (iii) |
| (3) | (ii) | (iv) | (iii) | (v) |
| (4) | (iii) | (iv) | (v) | (i) |

66. Match the following organisms with their respective characteristics :

- | | |
|--------------------------|-------------------------|
| (a) <i>Pila</i> | (i) Flame cells |
| (b) <i>Bombyx</i> | (ii) Comb plates |
| (c) <i>Pleurobrachia</i> | (iii) Radula |
| (d) <i>Taenia</i> | (iv) Malpighian tubules |

Select the **correct** option from the following :

- | | | | | |
|-----|-------|------|-------|------|
| | (a) | (b) | (c) | (d) |
| (1) | (iii) | (ii) | (iv) | (i) |
| (2) | (iii) | (ii) | (i) | (iv) |
| (3) | (iii) | (iv) | (ii) | (i) |
| (4) | (ii) | (iv) | (iii) | (i) |

67. Select the hormone-releasing Intra-Uterine Devices.

- (1) Lippes Loop, Multiload 375
- (2) Vaults, LNG-20
- (3) Multiload 375, Progestasert
- (4) Progestasert, LNG-20

68. The concept of "Omnis cellula-e cellula" regarding cell division was first proposed by :

- (1) Aristotle
- (2) Rudolf Virchow
- (3) Theodore Schwann
- (4) Schleiden

69. What is the genetic disorder in which an individual has an overall masculine development, gynaecomastia, and is sterile ?

- (1) Down's syndrome
- (2) Turner's syndrome
- (3) Klinefelter's syndrome
- (4) Edward syndrome

70. The shorter and longer arms of a submetacentric chromosome are referred to as :

- (1) m-arm and n-arm respectively
- (2) s-arm and l-arm respectively
- (3) p-arm and q-arm respectively
- (4) q-arm and p-arm respectively

71. What is the fate of the male gametes discharged in the synergid ?

- (1) One fuses with the egg and other fuses with central cell nuclei.
- (2) One fuses with the egg, other(s) degenerate(s) in the synergid.
- (3) All fuse with the egg.
- (4) One fuses with the egg, other(s) fuse(s) with synergid nucleus.

72. Match Column - I with Column - II.

- | Column - I | Column - II |
|----------------|---|
| (a) Saprophyte | (i) Symbiotic association of fungi with plant roots |
| (b) Parasite | (ii) Decomposition of dead organic materials |
| (c) Lichens | (iii) Living on living plants or animals |
| (d) Mycorrhiza | (iv) Symbiotic association of algae and fungi |

Choose the **correct** answer from the options given below :

- | | | | | |
|-----|-------|-------|-------|------|
| | (a) | (b) | (c) | (d) |
| (1) | (ii) | (iii) | (iv) | (i) |
| (2) | (i) | (ii) | (iii) | (iv) |
| (3) | (iii) | (ii) | (i) | (iv) |
| (4) | (ii) | (i) | (iii) | (iv) |

73. *Thiobacillus* is a group of bacteria helpful in carrying out :

- (1) Denitrification
 (2) Nitrogen fixation
 (3) Chemoautotrophic fixation
 (4) Nitrification

74. Tidal Volume and Expiratory Reserve Volume of an athlete is 500 mL and 1000 mL respectively. What will be his Expiratory Capacity if the Residual Volume is 1200 mL ?

- (1) 2700 mL
 (2) 1500 mL
 (3) 1700 mL
 (4) 2200 mL

75. Match the following genes of the Lac operon with their respective products :

- | | |
|------------|----------------------------|
| (a) i gene | (i) β -galactosidase |
| (b) z gene | (ii) Permease |
| (c) a gene | (iii) Repressor |
| (d) y gene | (iv) Transacetylase |

Select the **correct** option.

- | | (a) | (b) | (c) | (d) |
|-----|-------|-------|------|------|
| (1) | (iii) | (iv) | (i) | (ii) |
| (2) | (i) | (iii) | (ii) | (iv) |
| (3) | (iii) | (i) | (ii) | (iv) |
| (4) | (iii) | (i) | (iv) | (ii) |

76. Select the **correct** sequence of organs in the alimentary canal of cockroach starting from mouth :

- (1) Pharynx \rightarrow Oesophagus \rightarrow Ileum \rightarrow Crop \rightarrow Gizzard \rightarrow Colon \rightarrow Rectum
 (2) Pharynx \rightarrow Oesophagus \rightarrow Crop \rightarrow Gizzard \rightarrow Ileum \rightarrow Colon \rightarrow Rectum
 (3) Pharynx \rightarrow Oesophagus \rightarrow Gizzard \rightarrow Crop \rightarrow Ileum \rightarrow Colon \rightarrow Rectum
 (4) Pharynx \rightarrow Oesophagus \rightarrow Gizzard \rightarrow Ileum \rightarrow Crop \rightarrow Colon \rightarrow Rectum

77. Which of the following statements is **incorrect** ?

- (1) Prions consist of abnormally folded proteins.
 (2) Viroids lack a protein coat.
 (3) Viruses are obligate parasites.
 (4) Infective constituent in viruses is the protein coat.

78. Which of these following methods is the most suitable for disposal of nuclear waste ?

- (1) Bury the waste within rocks deep below the Earth's surface
 (2) Shoot the waste into space
 (3) Bury the waste under Antarctic ice-cover
 (4) Dump the waste within rocks under deep ocean

79. Which one of the following is **not** a method of *in situ* conservation of biodiversity ?

- (1) Sacred Grove
 (2) Biosphere Reserve
 (3) Wildlife Sanctuary
 (4) Botanical Garden

80. Persistent nucellus in the seed is known as :

- (1) Tegmen
 (2) Chalaza
 (3) Perisperm
 (4) Hilum

81. Which part of the brain is responsible for thermoregulation ?

- (1) Medulla oblongata
 (2) Cerebrum
 (3) Hypothalamus
 (4) Corpus callosum

82. What is the site of perception of photoperiod necessary for induction of flowering in plants ?

- (1) Leaves
 (2) Lateral buds
 (3) Pulvinus
 (4) Shoot apex

83. Which of the following immune responses is responsible for rejection of kidney graft ?

- (1) Cell-mediated immune response
 (2) Auto-immune response
 (3) Humoral immune response
 (4) Inflammatory immune response

84. Which of the following statements is **correct** ?
- (1) Cornea consists of dense matrix of collagen and is the most sensitive portion of the eye.
 - (2) Cornea is an external, transparent and protective proteinaceous covering of the eye-ball.
 - (3) Cornea consists of dense connective tissue of elastin and can repair itself.
 - (4) Cornea is convex, transparent layer which is highly vascularised.
85. Which of the following statements is **incorrect** ?
- (1) Yeasts have filamentous bodies with long thread-like hyphae.
 - (2) Morels and truffles are edible delicacies.*
 - (3) *Claviceps* is a source of many alkaloids and LSD.
 - (4) Conidia are produced exogenously and ascospores endogenously.†
86. Drug called 'Heroin' is synthesized by :
- (1) nitration of morphine
 - (2) methylation of morphine
 - (3) acetylation of morphine
 - (4) glycosylation of morphine
87. Identify the **correct** pair representing the causative agent of typhoid fever and the confirmatory test for typhoid.
- (1) *Salmonella typhi* / Widal test
 - (2) *Plasmodium vivax* / UTI test
 - (3) *Streptococcus pneumoniae* / Widal test
 - (4) *Salmonella typhi* / Anthrone test
88. A gene locus has two alleles A, a. If the frequency of dominant allele A is 0.4, then what will be the frequency of homozygous dominant, heterozygous and homozygous recessive individuals in the population ?
- (1) 0.16 (AA); 0.36 (Aa); 0.48 (aa)
 - (2) 0.36 (AA); 0.48 (Aa); 0.16 (aa)
 - (3) 0.16 (AA); 0.24 (Aa); 0.36 (aa)
 - (4) 0.16 (AA); 0.48 (Aa); 0.36 (aa)
89. In *Antirrhinum* (Snapdragon), a red flower was crossed with a white flower and in F₁ generation, pink flowers were obtained. When pink flowers were selfed, the F₂ generation showed white, red and pink flowers. Choose the **incorrect** statement from the following :
- (1) Law of Segregation does not apply in this experiment.
 - (2) This experiment does not follow the Principle of Dominance.*
 - (3) Pink colour in F₁ is due to incomplete dominance. †
 - (4) Ratio of F₂ is $\frac{1}{4}$ (Red) : $\frac{2}{4}$ (Pink) : $\frac{1}{4}$ (White) †
90. Grass leaves curl inwards during very dry weather. Select the most appropriate reason from the following :
- (1) Tyloses in vessels
 - (2) Closure of stomata
 - (3) Flaccidity of bulliform cells
 - (4) Shrinkage of air spaces in spongy mesophyll
91. Select the **correct** sequence for transport of sperm cells in male reproductive system.
- (1) Testis → Epididymis → Vasa efferentia → Vas deferens → Ejaculatory duct → Inguinal canal → Urethra → Urethral meatus
 - (2) Testis → Epididymis → Vasa efferentia → Rete testis → Inguinal canal → Urethra
 - (3) Seminiferous tubules → Rete testis → Vasa efferentia → Epididymis → Vas deferens → Ejaculatory duct → Urethra → Urethral meatus
 - (4) Seminiferous tubules → Vasa efferentia → Epididymis → Inguinal canal → Urethra
92. From evolutionary point of view, retention of the female gametophyte with developing young embryo on the parent sporophyte for some time, is first observed in :
- (1) Gymnosperms
 - (2) Liverworts
 - (3) Mosses
 - (4) Pteridophytes

93. Following statements describe the characteristics of the enzyme Restriction Endonuclease. Identify the **incorrect** statement.

- (1) The enzyme recognizes a specific palindromic nucleotide sequence in the DNA.
- (2) The enzyme cuts DNA molecule at identified position within the DNA.
- (3) The enzyme binds DNA at specific sites and cuts only one of the two strands.
- (4) The enzyme cuts the sugar-phosphate backbone at specific sites on each strand.

94. What map unit (Centimorgan) is adopted in the construction of genetic maps ?

- (1) A unit of distance between genes on chromosomes, representing 50% cross over.
- (2) A unit of distance between two expressed genes, representing 10% cross over.
- (3) A unit of distance between two expressed genes, representing 100% cross over.
- (4) A unit of distance between genes on chromosomes, representing 1% cross over.

95. Match the Column - I with Column - II :

| Column - I | Column - II |
|---------------------------------------|-----------------------------------|
| (a) P - wave | (i) Depolarisation of ventricles |
| (b) QRS complex | (ii) Repolarisation of ventricles |
| (c) T - wave | (iii) Coronary ischemia |
| (d) Reduction in the size of T - wave | (iv) Depolarisation of atria |
| | (v) Repolarisation of atria |

Select the **correct** option.

- (1) (ii) (iii) (v) (iv)
- (2) (iv) (i) (ii) (iii) ✗
- (3) (iv) (i) (ii) (v) ✗
- (4) (ii) (i) (v) (iii)

96. Which of the following pairs of gases is mainly responsible for green house effect ?

- (1) Carbon dioxide and Methane
- (2) Ozone and Ammonia
- (3) Oxygen and Nitrogen
- (4) Nitrogen and Sulphur dioxide

97. Xylem translocates :

- (1) Water, mineral salts, some organic nitrogen and hormones
- (2) Water only
- (3) Water and mineral salts only
- (4) Water, mineral salts and some organic nitrogen only

98. Which of the following muscular disorders is inherited ?

- (1) Botulism
- (2) Tetany
- (3) Muscular dystrophy
- (4) Myasthenia gravis

99. Match the following hormones with the respective disease :

| | |
|--------------------|-------------------------|
| (a) Insulin | (i) Addison's disease |
| (b) Thyroxin | (ii) Diabetes insipidus |
| (c) Corticoids | (iii) Acromegaly |
| (d) Growth Hormone | (iv) Goitre |
| | (v) Diabetes mellitus |

Select the **correct** option.

- (1) (a) (b) (c) (d)
- (2) (ii) (iv) (i) (iii)
- (3) (v) (i) (ii) (iii) ✗
- (4) (ii) (iv) (iii) (i) ✗
- (5) (v) (iv) (i) (iii)

100. Which of the following is the most important cause for animals and plants being driven to extinction ?

- (1) Alien species invasion
- (2) Habitat loss and fragmentation
- (3) Drought and floods
- (4) Economic exploitation

101. Which of the following is **true** for Golden rice ?
- (1) It has yellow grains, because of a gene introduced from a primitive variety of rice.
 - (2) It is Vitamin A enriched, with a gene from daffodil.
 - (3) It is pest resistant, with a gene from *Bacillus thuringiensis*.
 - (4) It is drought tolerant, developed using *Agrobacterium* vector.
102. Which of the following statements regarding mitochondria is **incorrect** ?
- (1) Mitochondrial matrix contains single circular DNA molecule and ribosomes. +
 - (2) Outer membrane is permeable to monomers of carbohydrates, fats and proteins.
 - (3) Enzymes of electron transport are embedded in outer membrane.
 - (4) Inner membrane is convoluted with infoldings. +
103. Which of the following protocols did aim for reducing emission of chlorofluorocarbons into the atmosphere ?
- (1) Geneva Protocol
 - (2) Montreal Protocol
 - (3) Kyoto Protocol
 - (4) Gothenburg Protocol
104. Respiratory Quotient (RQ) value of tripalmitin is :
- (1) 0.09
 - (2) 0.9
 - (3) 0.7
 - (4) 0.07
105. What is the direction of movement of sugars in phloem ?
- (1) Bi-directional
 - (2) Non-multidirectional
 - (3) Upward
 - (4) Downward
106. Which of the following pair of organelles **does not** contain DNA ?
- (1) Nuclear envelope and Mitochondria +
 - (2) Mitochondria and Lysosomes +
 - (3) Chloroplast and Vacuoles +
 - (4) Lysosomes and Vacuoles
107. Consider following features :
- (a) Organ system level of organisation
 - (b) Bilateral symmetry
 - (c) True coelomates with segmentation of body
- Select the **correct** option of animal groups which possess all the above characteristics.
- (1) Annelida, Mollusca and Chordata
 - (2) Annelida, Arthropoda and Chordata +
 - (3) Annelida, Arthropoda and Mollusca
 - (4) Arthropoda, Mollusca and Chordata
108. It takes very long time for pineapple plants to produce flowers. Which combination of hormones can be applied to artificially induce flowering in pineapple plants throughout the year to increase yield ?
- (1) Cytokinin and Abscisic acid +
 - (2) Auxin and Ethylene +
 - (3) Gibberellin and Cytokinin
 - (4) Gibberellin and Abscisic acid
109. Due to increasing air-borne allergens and pollutants, many people in urban areas are suffering from respiratory disorder causing wheezing due to :
- (1) reduction in the secretion of surfactants by pneumocytes.
 - (2) benign growth on mucous lining of nasal cavity.
 - (3) inflammation of bronchi and bronchioles.
 - (4) proliferation of fibrous tissues and damage of the alveolar walls.
110. Conversion of glucose to glucose-6-phosphate, the first irreversible reaction of glycolysis, is catalyzed by :
- (1) Phosphofructokinase
 - (2) Aldolase
 - (3) Hexokinase
 - (4) Enolase
111. Select the **correctly** written scientific name of Mango which was first described by Carolus Linnaeus :
- (1) *Mangifera Indica*
 - (2) *Mangifera indica* Car. Linn.
 - (3) *Mangifera indica* Linn.
 - (4) *Mangifera indica*

112. The frequency of recombination between gene pairs on the same chromosome as a measure of the distance between genes was explained by :
- (1) Sutton Boveri *
 - (2) T.H. Morgan
 - (3) Gregor J. Mendel *
 - (4) Alfred Sturtevant
113. Which one of the following equipments is essentially required for growing microbes on a large scale, for industrial production of enzymes ?
- (1) Bioreactor
 - (2) BOD incubator
 - (3) Sludge digester
 - (4) Industrial oven
114. Which of the following glucose transporters is insulin-dependent ?
- (1) GLUT IV
 - (2) GLUT I
 - (3) GLUT II
 - (4) GLUT III
115. Select the **correct** group of biocontrol agents.
- (1) *Nostoc*, *Azospirillum*, *Nucleopolyhedrovirus* *
 - (2) *Bacillus thuringiensis*, Tobacco mosaic virus, Aphids *
 - (3) *Trichoderma*, *Baculovirus*, *Bacillus thuringiensis* *
 - (4) *Oscillatoria*, *Rhizobium*, *Trichoderma*
116. The ciliated epithelial cells are required to move particles or mucus in a specific direction. In humans, these cells are mainly present in :
- (1) Bronchioles and Fallopian tubes
 - (2) Bile duct and Bronchioles
 - (3) Fallopian tubes and Pancreatic duct
 - (4) Eustachian tube and Salivary duct
117. Use of an artificial kidney during hemodialysis may result in :
- (a) Nitrogenous waste build-up in the body
 - (b) Non-elimination of excess potassium ions
 - (c) Reduced absorption of calcium ions from gastro-intestinal tract
 - (d) Reduced RBC production
- Which of the following options is the most **appropriate** ?
- (1) (a) and (d) are correct
 - (2) (a) and (b) are correct
 - (3) (b) and (c) are correct *
 - (4) (c) and (d) are correct *
118. The Earth Summit held in Rio de Janeiro in 1992 was called :
- (1) for immediate steps to discontinue use of CFCs that were damaging the ozone layer.
 - (2) to reduce CO₂ emissions and global warming.
 - (3) for conservation of biodiversity and sustainable utilization of its benefits.
 - (4) to assess threat posed to native species by invasive weed species.
119. Which of the following factors is responsible for the formation of concentrated urine ?
- (1) Hydrostatic pressure during glomerular filtration.
 - (2) Low levels of antidiuretic hormone.
 - (3) Maintaining hyperosmolarity towards inner medullary interstitium in the kidneys.
 - (4) Secretion of erythropoietin by Juxtaglomerular complex.
120. How does steroid hormone influence the cellular activities ?
- (1) Using aquaporin channels as second messenger. *
 - (2) Changing the permeability of the cell membrane.†
 - (3) Binding to DNA and forming a gene-hormone complex.
 - (4) Activating cyclic AMP located on the cell membrane.
121. What triggers activation of protoxin to active Bt toxin of *Bacillus thuringiensis* in boll worm ?
- (1) Acidic pH of stomach
 - (2) Body temperature
 - (3) Moist surface of midgut
 - (4) Alkaline pH of gut

122. Which of the statements given below is **not** true about formation of Annual Rings in trees ?
- (1) Annual rings are not prominent in trees of temperate region.
 - (2) Annual ring is a combination of spring wood and autumn wood produced in a year.
 - (3) Differential activity of cambium causes light and dark bands of tissue - early and late wood respectively.
 - (4) Activity of cambium depends upon variation in climate.

123. Match the following structures with their respective location in organs :

- | | |
|--------------------------|-----------------------|
| (a) Crypts of Lieberkühn | (i) Pancreas |
| (b) Glisson's Capsule | (ii) Duodenum |
| (c) Islets of Langerhans | (iii) Small intestine |
| (d) Brunner's Glands | (iv) Liver |

Select the **correct** option from the following :

- | | (a) | (b) | (c) | (d) |
|-----|-------|------|------|-------|
| (1) | (iii) | (ii) | (i) | (iv) |
| (2) | (iii) | (i) | (ii) | (iv) |
| (3) | (ii) | (iv) | (i) | (iii) |
| (4) | (iii) | (iv) | (i) | (ii) |
124. Which one of the following statements regarding post-fertilization development in flowering plants is **incorrect** ?
- (1) Ovules develop into embryo sac
 - (2) Ovary develops into fruit
 - (3) Zygote develops into embryo
 - (4) Central cell develops into endosperm

125. Polyblend, a fine powder of recycled modified plastic, has proved to be a good material for :
- (1) making tubes and pipes
 - (2) making plastic sacks
 - (3) use as a fertilizer
 - (4) construction of roads

126. Under which of the following conditions will there be no change in the reading frame of following mRNA ?

5' AACAGCGGUGCUAAU 3'

- (1) Deletion of GGU from 7th, 8th and 9th positions
 - (2) Insertion of G at 5th position
 - (3) Deletion of G from 5th position
 - (4) Insertion of A and G at 4th and 5th positions respectively
127. Colostrum, the yellowish fluid, secreted by mother during the initial days of lactation is very essential to impart immunity to the newborn infants because it contains :
- (1) Immunoglobulin A
 - (2) Natural killer cells
 - (3) Monocytes
 - (4) Macrophages

128. Which of the following statements is **not** correct ?

- (1) Lysosomes are formed by the process of packaging in the endoplasmic reticulum.
- (2) Lysosomes have numerous hydrolytic enzymes.
- (3) The hydrolytic enzymes of lysosomes are active under acidic pH.
- (4) Lysosomes are membrane bound structures.

129. Pinus seed **cannot** germinate and establish without fungal association. This is because :

- (1) its seeds contain inhibitors that prevent germination.
- (2) its embryo is immature.
- (3) it has obligate association with mycorrhizae.
- (4) it has very hard seed coat.

130. Cells in G₀ phase :

- (1) terminate the cell cycle
- (2) exit the cell cycle
- (3) enter the cell cycle
- (4) suspend the cell cycle

131. Select the **incorrect** statement.

- (1) Human males have one of their sex-chromosome much shorter than the other.
- (2) Male fruit fly is heterogametic.
- (3) In male grasshoppers, 50% of sperms have no sex-chromosome.
- (4) In domesticated fowls, sex of progeny depends on the type of sperm rather than egg.

132. In some plants, the female gamete develops into embryo without fertilization. This phenomenon is known as :

- (1) Parthenogenesis
- (2) Autogamy
- (3) Parthenocarp
- (4) Syngamy

133. Extrusion of second polar body from egg nucleus occurs :

- (1) simultaneously with first cleavage
- (2) after entry of sperm but before fertilization
- (3) after fertilization
- (4) before entry of sperm into ovum

134. Select the **incorrect** statement.

- (1) Inbreeding helps in accumulation of superior genes and elimination of undesirable genes.
- (2) Inbreeding increases homozygosity.
- (3) Inbreeding is essential to evolve purelines in any animal.
- (4) Inbreeding selects harmful recessive genes that reduce fertility and productivity.

135. Placentation, in which ovules develop on the inner wall of the ovary or in peripheral part, is :

- (1) Free central
- (2) Basal
- (3) Axile
- (4) Parietal

136. Which colour of the light has the longest wavelength?

- (1) violet
- (2) red
- (3) blue
- (4) green

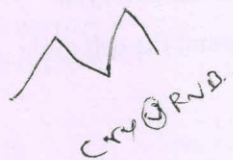

137. A particle moving with velocity \vec{V} is acted by three forces shown by the vector triangle PQR. The velocity of the particle will :

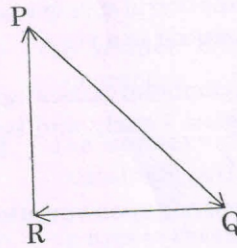

- (1) change according to the smallest force \vec{QR}
- (2) increase
- (3) decrease
- (4) remain constant

138. In which of the following processes, heat is neither absorbed nor released by a system?

- (1) isochoric
- (2) isothermal
- (3) adiabatic
- (4) isobaric

139. Two point charges A and B, having charges $+Q$ and $-Q$ respectively, are placed at certain distance apart and force acting between them is F . If 25% charge of A is transferred to B, then force between the charges becomes :

- (1) $\frac{4F}{3}$
- (2) F
- (3) $\frac{9F}{16}$
- (4) $\frac{16F}{9}$

140. The displacement of a particle executing simple harmonic motion is given by

$$y = A_0 + A \sin \omega t + B \cos \omega t.$$

Then the amplitude of its oscillation is given by :

- (1) $A+B$
- (2) $A_0 + \sqrt{A^2 + B^2}$
- (3) $\sqrt{A^2 + B^2}$
- (4) $\sqrt{A_0^2 + (A+B)^2}$

$$A = \sqrt{A^2 + B^2}$$

141.

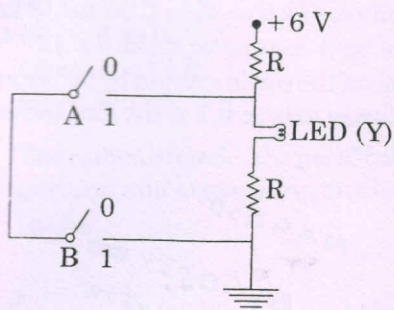

The **correct** Boolean operation represented by the circuit diagram drawn is :

- (1) NOR
 (2) AND
 (3) OR
 (4) NAND
142. A solid cylinder of mass 2 kg and radius 4 cm is rotating about its axis at the rate of 3 rpm. The torque required to stop after 2π revolutions is :
- (1) 2×10^6 N m
 (2) 2×10^{-6} N m
 (3) 2×10^{-3} N m
 (4) 12×10^{-4} N m
143. For a p-type semiconductor, which of the following statements is **true** ?
- (1) Electrons are the majority carriers and pentavalent atoms are the dopants.
 (2) Electrons are the majority carriers and trivalent atoms are the dopants.
 (3) Holes are the majority carriers and trivalent atoms are the dopants.
 (4) Holes are the majority carriers and pentavalent atoms are the dopants.

144. A disc of radius 2 m and mass 100 kg rolls on a horizontal floor. Its centre of mass has speed of 20 cm/s. How much work is needed to stop it ?

- (1) 1 J
 (2) 3 J
 (3) 30 kJ
 (4) 2 J

$r = 2$
 $M = 100 \text{ kg}$
 $v = 20 \text{ cm/s}$

145. Which of the following acts as a circuit protection device ?

- (1) fuse
 (2) conductor
 (3) inductor
 (4) switch

146. In an experiment, the percentage of error occurred in the measurement of physical quantities A, B, C and D are 1%, 2%, 3% and 4% respectively. Then the maximum percentage of error in the

measurement X, where $X = \frac{A^2 B^{1/2}}{C^{1/3} D^3}$, will be :

- (1) 10%
 (2) $\left(\frac{3}{13}\right)\%$
 (3) 16%
 (4) -10%

147. Ionized hydrogen atoms and α -particles with same momenta enters perpendicular to a constant magnetic field, B. The ratio of their radii of their paths $r_H : r_\alpha$ will be :

- (1) 1 : 4
 (2) 2 : 1
 (3) 1 : 2
 (4) 4 : 1

148. A cylindrical conductor of radius R is carrying a constant current. The plot of the magnitude of the magnetic field, B with the distance, d , from the centre of the conductor, is **correctly** represented by the figure :

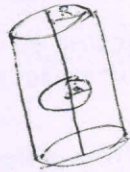
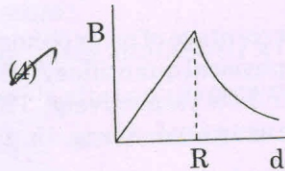
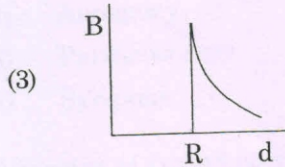
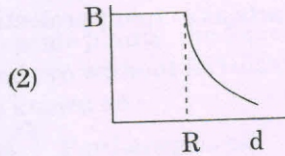
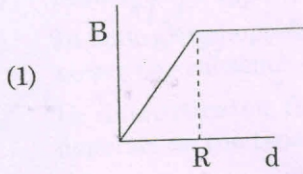

149. At a point A on the earth's surface the angle of dip, $\delta = +25^\circ$. At a point B on the earth's surface the angle of dip, $\delta = -25^\circ$. We can interpret that :

- (1) A and B are both located in the southern hemisphere.
- (2) A and B are both located in the northern hemisphere.
- (3) A is located in the southern hemisphere and B is located in the northern hemisphere.
- (4) A is located in the northern hemisphere and B is located in the southern hemisphere.

150. A mass m is attached to a thin wire and whirled in a vertical circle. The wire is most likely to break when :

- (1) inclined at an angle of 60° from vertical
- (2) the mass is at the highest point
- (3) the wire is horizontal
- (4) the mass is at the lowest point

151. A 800 turn coil of effective area 0.05 m^2 is kept perpendicular to a magnetic field $5 \times 10^{-5} \text{ T}$. When the plane of the coil is rotated by 90° around any of its coplanar axis in 0.1 s , the emf induced in the coil will be :

- (1) 0.02 V
- (2) 2 V
- (3) 0.2 V
- (4) $2 \times 10^{-3} \text{ V}$

$= NAB \cos \theta$
 $= 800 \times 0.05 \times 5 \times 10^{-5}$
 $= 2 \times 10^{-3} \text{ V}$

152. In total internal reflection when the angle of incidence is equal to the critical angle for the pair of media in contact, what will be angle of refraction ?

- (1) 90°
- (2) 180°
- (3) 0°
- (4) equal to angle of incidence

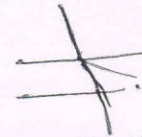

153. The work done to raise a mass m from the surface of the earth to a height h , which is equal to the radius of the earth, is :

- (1) $\frac{3}{2} mgR$
- (2) mgR
- (3) $2 mgR$
- (4) $\frac{1}{2} mgR$

154. A force $F = 20 + 10y$ acts on a particle in y -direction where F is in newton and y in meter. Work done by this force to move the particle from $y = 0$ to $y = 1 \text{ m}$ is :

(1) 20 J
 (2) 30 J
 (3) 5 J
 (4) 25 J

$W = \int_0^1 (20 + 10y) dy$
 $= [20y + 5y^2]_0^1$
 $= 20 + 5 = 25 \text{ J}$

155. Two similar thin equi-convex lenses, of focal length f each, are kept coaxially in contact with each other such that the focal length of the combination is F_1 . When the space between the two lenses is filled with glycerin (which has the same refractive index ($\mu = 1.5$) as that of glass) then the equivalent focal length is F_2 . The ratio $F_1 : F_2$ will be :

- (1) $3 : 4$
- (2) $2 : 1$
- (3) $1 : 2$
- (4) $2 : 3$

56. The unit of thermal conductivity is :

- (1) $W m^{-1} K^{-1}$
- (2) $J m K^{-1} s$
- (3) $J m^{-1} K^{-1}$
- (4) $W m K^{-1} s$

157. The radius of circle, the period of revolution, initial position and sense of revolution are indicated in the fig.

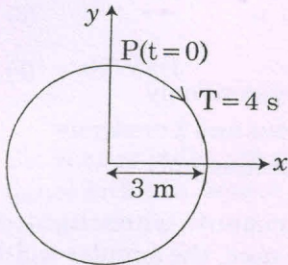

y - projection of the radius vector of rotating particle P is :

- (1) $y(t) = 3 \cos\left(\frac{\pi t}{2}\right)$, where y in m
- (2) $y(t) = -3 \cos 2\pi t$, where y in m
- (3) $y(t) = 4 \sin\left(\frac{\pi t}{2}\right)$, where y in m
- (4) $y(t) = 3 \cos\left(\frac{3\pi t}{2}\right)$, where y in m

158. When a block of mass M is suspended by a long wire of length L, the length of the wire becomes (L+l). The elastic potential energy stored in the extended wire is :

- (1) $\frac{1}{2} MgL$
- (2) Mgl
- (3) MgL
- (4) $\frac{1}{2} Mgl$

159. Pick the **wrong** answer in the context with rainbow.

- (1) Rainbow is a combined effect of dispersion, refraction and reflection of sunlight. \times
- (2) When the light rays undergo two internal reflections in a water drop, a secondary rainbow is formed. λ
- (3) The order of colours is reversed in the secondary rainbow. λ
- (4) An observer can see a rainbow when his front is towards the sun. \times

160. An electron is accelerated through a potential difference of 10,000 V. Its de Broglie wavelength is, (nearly) : ($m_e = 9 \times 10^{-31} \text{ kg}$)

- (1) 12.2 nm
- (2) $12.2 \times 10^{-13} \text{ m}$
- (3) $12.2 \times 10^{-12} \text{ m}$
- (4) $12.2 \times 10^{-14} \text{ m}$

$$V = 10000$$

$$m = 9 \times 10^{-31}$$

$$\lambda = \frac{h}{\sqrt{2mV}}$$

161. A body weighs 200 N on the surface of the earth. How much will it weigh half way down to the centre of the earth ?

- (1) 100 N $\cancel{W} = 200 \text{ N}$
- (2) 150 N
- (3) 200 N
- (4) 250 N

162. A parallel plate capacitor of capacitance $20 \mu\text{F}$ is being charged by a voltage source whose potential is changing at the rate of 3 V/s . The conduction current through the connecting wires, and the displacement current through the plates of the capacitor, would be, respectively :

- (1) zero, zero $C = 20 \mu\text{F}$ $v = 3 \text{ V/s}$
- (2) zero, $60 \mu\text{A}$
- (3) $60 \mu\text{A}$, $60 \mu\text{A}$
- (4) $60 \mu\text{A}$, zero

163. In the circuits shown below, the readings of the voltmeters and the ammeters will be :

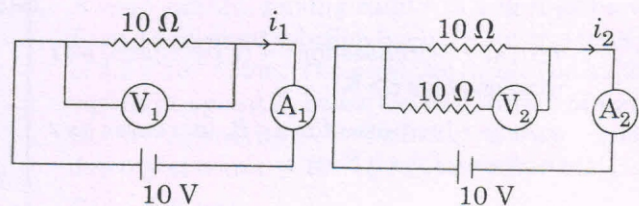

Circuit 1

Circuit 2

- (1) $V_2 > V_1$ and $i_1 > i_2$
- (2) $V_2 > V_1$ and $i_1 = i_2$
- (3) $V_1 = V_2$ and $i_1 > i_2$
- (4) $V_1 = V_2$ and $i_1 = i_2$

164. When an object is shot from the bottom of a long smooth inclined plane kept at an angle 60° with horizontal, it can travel a distance x_1 along the plane. But when the inclination is decreased to 30° and the same object is shot with the same velocity, it can travel x_2 distance. Then $x_1 : x_2$ will be :
- (1) $1 : 2\sqrt{3}$
 - (2) $1 : \sqrt{2}$
 - (3) $\sqrt{2} : 1$
 - (4) $1 : \sqrt{3}$
165. Body A of mass $4m$ moving with speed u collides with another body B of mass $2m$, at rest. The collision is head on and elastic in nature. After the collision the fraction of energy lost by the colliding body A is :
- (1) $\frac{5}{9}$
 - (2) $\frac{1}{9}$
 - (3) $\frac{8}{9}$
 - (4) $\frac{4}{9}$
166. A hollow metal sphere of radius R is uniformly charged. The electric field due to the sphere at a distance r from the centre :
- (1) decreases as r increases for $r < R$ and for $r > R$
 - (2) increases as r increases for $r < R$ and for $r > R$
 - (3) zero as r increases for $r < R$, decreases as r increases for $r > R$
 - (4) zero as r increases for $r < R$, increases as r increases for $r > R$
167. In which of the following devices, the eddy current effect is **not** used ?
- (1) electric heater
 - (2) induction furnace
 - (3) magnetic braking in train
 - (4) electromagnet
168. Two particles A and B are moving in uniform circular motion in concentric circles of radii r_A and r_B with speed v_A and v_B respectively. Their time period of rotation is the same. The ratio of angular speed of A to that of B will be :
- (1) $1 : 1$
 - (2) $r_A : r_B$
 - (3) $v_A : v_B$
 - (4) $r_B : r_A$
169. α -particle consists of :
- (1) 2 protons only
 - (2) 2 protons and 2 neutrons only
 - (3) 2 electrons, 2 protons and 2 neutrons
 - (4) 2 electrons and 4 protons only
170. In a double slit experiment, when light of wavelength 400 nm was used, the angular width of the first minima formed on a screen placed 1 m away, was found to be 0.2° . What will be the angular width of the first minima, if the entire experimental apparatus is immersed in water ? ($\mu_{\text{water}} = 4/3$)
- (1) 0.1°
 - (2) 0.266°
 - (3) 0.15°
 - (4) 0.05°
171. The total energy of an electron in an atom in an orbit is -3.4 eV . Its kinetic and potential energies are, respectively :
- (1) $3.4 \text{ eV}, 3.4 \text{ eV}$ $= 7 \times K.E$
 - (2) $-3.4 \text{ eV}, -3.4 \text{ eV}$
 - (3) $-3.4 \text{ eV}, -6.8 \text{ eV}$ $P.E = 2 \times K.E$
 - (4) $3.4 \text{ eV}, -6.8 \text{ eV}$
172. A small hole of area of cross-section 2 mm^2 is present near the bottom of a fully filled open tank of height 2 m . Taking $g = 10 \text{ m/s}^2$, the rate of flow of water through the open hole would be nearly :
- (1) $6.4 \times 10^{-6} \text{ m}^3/\text{s}$
 - (2) $12.6 \times 10^{-6} \text{ m}^3/\text{s}$
 - (3) $8.9 \times 10^{-6} \text{ m}^3/\text{s}$
 - (4) $2.23 \times 10^{-6} \text{ m}^3/\text{s}$
173. A copper rod of 88 cm and an aluminium rod of unknown length have their increase in length independent of increase in temperature. The length of aluminium rod is : ($\alpha_{\text{Cu}} = 1.7 \times 10^{-5} \text{ K}^{-1}$ and $\alpha_{\text{Al}} = 2.2 \times 10^{-5} \text{ K}^{-1}$)
- (1) 68 cm
 - (2) 6.8 cm
 - (3) 113.9 cm
 - (4) 88 cm

74. The speed of a swimmer in still water is 20 m/s. The speed of river water is 10 m/s and is flowing due east. If he is standing on the south bank and wishes to cross the river along the shortest path, the angle at which he should make his strokes w.r.t. north is given by :

- (1) 45° west
- (2) 30° west
- (3) 0°
- (4) 60° west

175. Six similar bulbs are connected as shown in the figure with a DC source of emf E , and zero internal resistance.

The ratio of power consumption by the bulbs when (i) all are glowing and (ii) in the situation when two from section A and one from section B are glowing, will be :

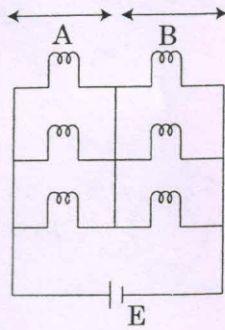

- (1) 2 : 1
- (2) 4 : 9
- (3) 9 : 4
- (4) 1 : 2

176. Average velocity of a particle executing SHM in one complete vibration is :

- (1) zero
- (2) $\frac{A\omega}{2}$
- (3) $A\omega$
- (4) $\frac{A\omega^2}{2}$

177. Increase in temperature of a gas filled in a container would lead to :

- (1) decrease in intermolecular distance
- (2) increase in its mass
- (3) increase in its kinetic energy
- (4) decrease in its pressure

178. Two parallel infinite line charges with linear charge densities $+\lambda$ C/m and $-\lambda$ C/m are placed at a distance of $2R$ in free space. What is the electric field mid-way between the two line charges ?

- (1) $\frac{\lambda}{2\pi\epsilon_0 R}$ N/C
- (2) zero
- (3) $\frac{2\lambda}{\pi\epsilon_0 R}$ N/C
- (4) $\frac{\lambda}{\pi\epsilon_0 R}$ N/C

179. A block of mass 10 kg is in contact against the inner wall of a hollow cylindrical drum of radius 1 m. The coefficient of friction between the block and the inner wall of the cylinder is 0.1. The minimum angular velocity needed for the cylinder to keep the block stationary when the cylinder is vertical and rotating about its axis, will be : ($g = 10 \text{ m/s}^2$)

- (1) 10π rad/s
- (2) $\sqrt{10}$ rad/s
- (3) $\frac{10}{2\pi}$ rad/s
- (4) 10 rad/s

180. A soap bubble, having radius of 1 mm, is blown from a detergent solution having a surface tension of 2.5×10^{-2} N/m. The pressure inside the bubble equals at a point Z_0 below the free surface of water in a container. Taking $g = 10 \text{ m/s}^2$, density of water = 10^3 kg/m^3 , the value of Z_0 is :

- (1) 0.5 cm
- (2) 100 cm
- (3) 10 cm
- (4) 1 cm